

EEG-based Brain-computer Interface for Automating Home Appliances

Abdel Ilah N. Alshbatat
 Tafila Technical University, Tafila, Jordan
 Email: a.alshabatat@ttu.edu.jo

Peter J. Vial, Prashan Premaratne, Le C. Tran
 University of Wollongong, Wollongong, Australia
 Email: {peterv, prashan, lctran}@uow.edu.au

Abstract—An EEG-based brain-computer system for automating home appliances is proposed in this study. Brain-computer interface (BCI) system provides direct pathway between human brain and external computing resources or external devices. The system translates thought into action without using muscles through a number of electrodes attached to the user’s scalp. The BCI technology can be used by disabled people to improve their independence and maximize their capabilities at home. In this paper, a novel BCI system was developed to control home appliances from a dedicated Graphical User Interface (GUI). The system is structured with six units: EMOTIV EPOC headset, personal computer, Flyport module, quad band GSM/GPRS communication module, LinkSprite JPEG Colour camera, and PIC-P40 board. EMOTIV EPOC headset detects and records neuronal electrical activities that reflect user’s intent from different locations on the scalp. Those activities are then sent to the computer to extract specific signal features. Those features are then translated into commands to operate all appliances at home. The proposed system has been implemented, constructed, and tested. Experimental results demonstrates the feasibility of our proposed BCI system in controlling home appliances based on the user’s physiological states.

Index Terms— Brain-Computer Interface (BCI), Electroencephalogram (EEG), EMOTIV EPOC Neuroheadset, Signal Processing

I. INTRODUCTION

Paralysis is usually caused by problems with the spinal cord that the brain uses to pass control messages to muscles. Therefore, patients who are suffering from this severe problem need a great deal of support to enhance their ability to carry out daily activities. As a result, this problem has an impact on a person's quality of life and adds a high cost for the residential care packages since another person is needed to serve patient and satisfy his needs. In reviewing the literature, researchers are focusing on finding a technology that could be used by individuals who are affected by this problem. The goal

was to develop devices that could be steered by the electrical activity of the brain using external electrodes attached to the user’s scalp. BCI technology was envisioned as a promising and useful strategy that could give patients who are severely physically disabled new abilities to interact with the world around them through their mental activity [1].

As shown in Fig.1, BCI is an emerging system that recognizes user brainwaves and reacts according to them. The system measures and analyses brain signals and then translate them into commands to control external devices such as wheelchair, TV, and light system [2, 3]. Brainwaves are acquired by electroencephalography (EEG) sensors. An electroencephalogram is a test to measure the electrical activity of the brain. This test is used as a non-invasive technology in which electrodes are implanted directly on the scalp [4]. The electrodes are named according to their locations on the scalp; Fig. 2, and given a letter that reflects its position on the skull hemisphere. As shown in Fig. 3, Emotiv neuroheadset houses fourteen EEG and two reference sensors. The letters F, T, C, P, and O stand for frontal, temporal, central, parietal, and occipital lobes respectively. The electrodes are arranged in pairs so as to measure the differences in voltage between neurons. Three pairs of sensors are positioned on the occipital lobe, parietal lobe, and temporal lobes respectively. Another three pairs of sensors are positioned around the frontal lobe, and the last pair is positioned between the temporal and frontal lobes. Table I shows some important characteristics related to this neuroheadset. The signal collecting by those sensors is amplified, filtered through a band pass filter and transferred to the PC to perform FFT frequency analysis. Processing of EEG data includes features extraction that reflects user’s intent. Those features are then transferred to actions [5].

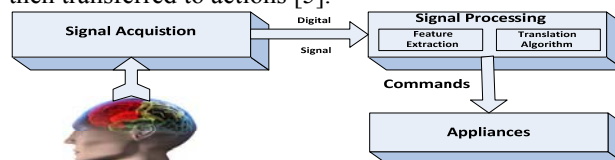

Figure 1. Basic Design of BCI system.

Manuscript received February 2, 2014; revised March 27, 2014; accepted April 9, 2014.

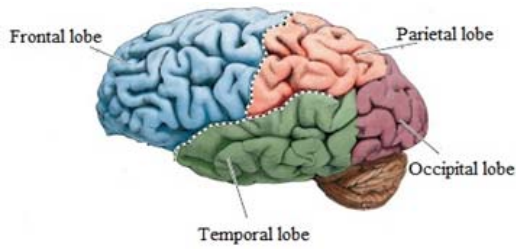

Figure 2. Adult human brain is divided into four lobes: frontal, temporal, parietal, and occipital lobe

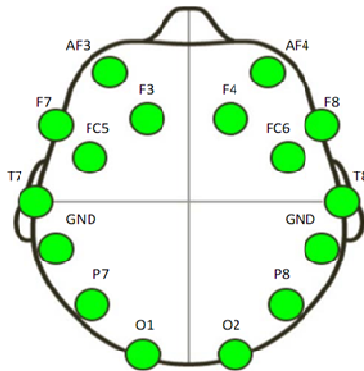

Figure 3. Location of the fourteen channels by EMOTIV EPOC.

TABLE I:
CHARACTERISTICS OF EMOTIV EEG NEUROHEADSET.

EEG sensors	AF3, AF4, F3, F4, F7, F8, FC5, FC6, P7, P8, T7, T8, O1, O2
Reference sensors	P3(CMS), P4 (DRL)
Sampling method	Sequential sampling
Sampling rate	128 Hz
Bandwidth	0.2-45 Hz
Connectivity	2.4 GHz
Resolution	16 bits
Battery	lithium polymer

Brainwaves recorded by EEG sensors are characterized by amplitude and frequency. Amplitude ranges from 0 up to 100 microvolt's, while frequencies range from 1Hz up to 100 Hz. Brainwaves are in general divided into five categories: Delta, Theta, Alpha, Beta, and Gamma. Delta rhythm has the frequency range of 1–4 Hz and is associated with coma and dreamless sleep. This rhythm is seen frequently in adults, and premature babies. In adults, it can be found in the frontal region of the brain, while in premature babies, it can be found in the posterior region of brain. Theta rhythm has the frequency range of 4–8 Hz and associated with drowsiness, deep meditation, emotions, and dream sleep. This rhythm is observed in young children, adults and can be found in parietal and occipital region of the brain. Both Delta and Theta rhythm are categorized as slower brainwaves where the person can feel tired, slow, sluggish, or dreamy.

Alpha rhythm has the frequency range of 8–13 Hz and is associated with a relaxed state of mind, and conscious attention. This rhythm is observed in the period after waking, and right before sleeping. It can be found in most people in the awake condition with closed eyes within the occipital region. Beta rhythm has the frequency range of

13–30 Hz and is associated with alertness, intention, concentration, problem solving, judgment, decision making, and motor activities. This rhythm can be found in the frontal and parietal region. Gamma rhythm has the frequency range of 30–42 Hz and is associated with certain motor functions, high energy states such as when we are afraid or when we are concentrating on a complex task [6].

In this paper, we aim to help owners of physical disabilities in improving their life quality and be able to open and close doors, switch on and switch off the light, control the television, use the mobile phone, send messages to people in their community, and operate a video camera at the home entrance. To satisfy this goal, we develop a real-time wireless EEG-based BCI system. The remainder of this paper is organized as follows: Section 2 presents a brief survey of the related work. In section 3, we explain the system architecture, hardware and software design. In section 4, experiments were performed and results are explained. Finally, we conclude and discuss future work in section 5.

II. LITERATURE REVIEW

Many environmental control systems were proposed and applied for people with disability to control their surroundings [7]. Radio frequency identification and voice recognition [8] are some of these systems. Those systems work well for people with motion disability while they will not work for people with voice or vision impairment. Other systems using human's physiological state were proposed. The author in [9] proposed a BCI system to help disabled people to input phone numbers. The system is based on the steady-state visual evoked potential where twelve buttons are illuminated in front of the user at different rates. To this end, disabled people could input a phone number by gazing at those buttons.

Interaction between user's brain and computer was achieved through a number of ways: Visual Evoked Potentials (VEP), Slow Cortical Potentials [10], P300 potentials, N400 potentials, and Sensory Motor Rhythm (SMR). To this end, VEP refers to the electrical potential recorded from the visual cortex in response to stimulation of light [11]; P300 is an event related potential (ERP, recorded in response to the occurrence of a discrete event, especially when the subject is actively engaged in the task of detecting the targets). This signal appears approximately 300ms after some infrequent stimuli and typically measured by the electrodes covering the parietal lobe [12].

Several techniques were used in the previous methods to extract and classify features form brain signals. Wavelet-based feature extraction algorithms were introduced in [13]. Artificial Neural Network (ANN) has been used by [14] for cortical control of arm prosthetics. Moreover, Power Spectral Density (PSD) [15], Band Powers (BP) [16], Adaptive Auto Regressive (AAR) [17], were also used for feature extractions. A great variety of classification algorithms was also used to design BCI systems. Linear Discriminant Analysis [18], Support Vector Machine (SVM) [19], and Hidden Markov Model

[20] are some of those classifiers presented in the literature.

III. SYSTEM DESCRIPTION

In this work, we have successfully developed a wireless portable BCI system to detect and process user thought in a real-time. As shown in Fig. 4, and Fig. 5, the system is generally divided into two blocks: Transmitter block and Receiver block. Transmitter block is divided into six sub-blocks: One Neuroheadset, three wireless modules, one PC and one converter. On the other side, one wireless module, two PIC microcontrollers, one GSM module, and two appliances blocks were dedicated for the receiving side. Following is a description of the micro-architectural design of each module.

A. System Architecture

As shown in Fig. 4, EEG raw signal from the user scalp is collected, amplified, digitized and transmitted through a Bluetooth module to the personal computer using EMOTIV EPOC headset. EMOTIV headset measures EEG signal from 14 locations positioned at: AF3, AF4, F3, F4, F7, F8, FC5, FC6, P7, P8, T7, T8, O1, and O2. EmoEngine is an application provided by EMOTIV to decode, process data and match them to the trained patterns of the subject. This application provides three suites including Expressive, Affective, and Cognitive. Those suites are grouped by a tool called Control Panel, Fig. 6. A Cognitive suite as shown in Fig. 7 is used in this study where users can train the system to detect a specific thought. All subjects trained with the Cognitive suite to control left, right, pull, and push movements of a virtual cube. Along with this tool comes EMOTIV Emokey suite, Fig. 8. Emokey is used for mapping subject thoughts to keyboard input. Those inputs are then read and sent as a command through a WiFi module to the receiver block.

Another WiFi module is used as shown in Fig. 5. This module receives commands from the wireless device and directs them to the microcontroller. Two PIC16F877 microcontrollers as shown in Fig. 9 are used to process commands sent by the subjects. The first microcontroller is used as a command decoder and a driver for some of hardware appliances like the light system. The second microcontroller is programmed to control other appliances and send some text messages once the physiological state is detected to a predefined user. Text messaging was implemented by a quad band GSM/GPRS communication module.

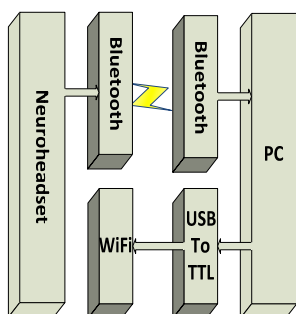

Figure 4. System architecture, transmitter block.

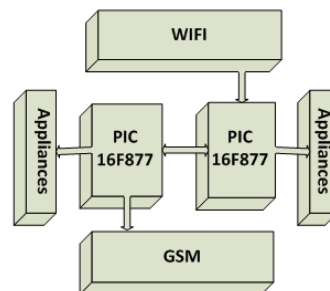

Figure.5 System architecture, receiver block.

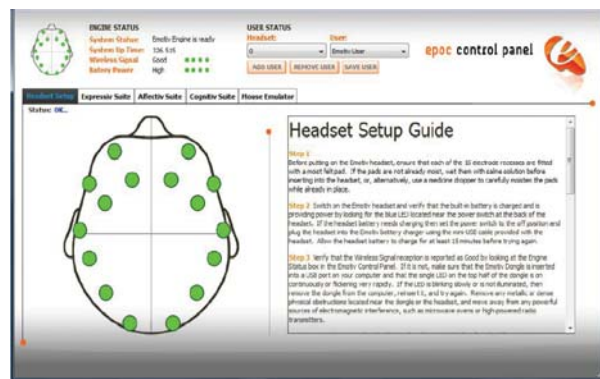

Figure 6. Control Panel.

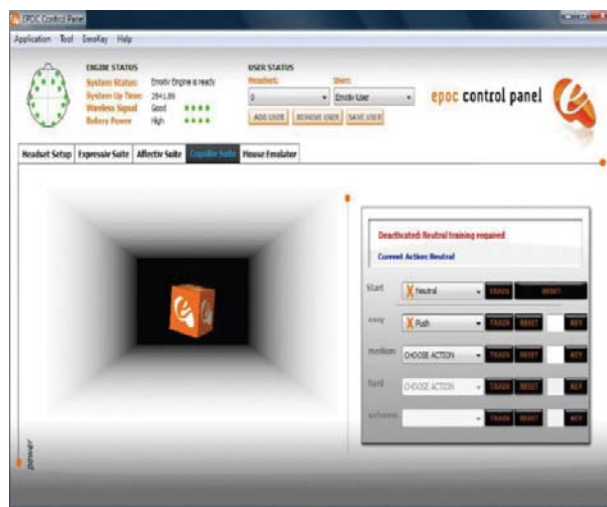

Figure 7. Cognitive Suite.



Figure 8. Emokey Suite.

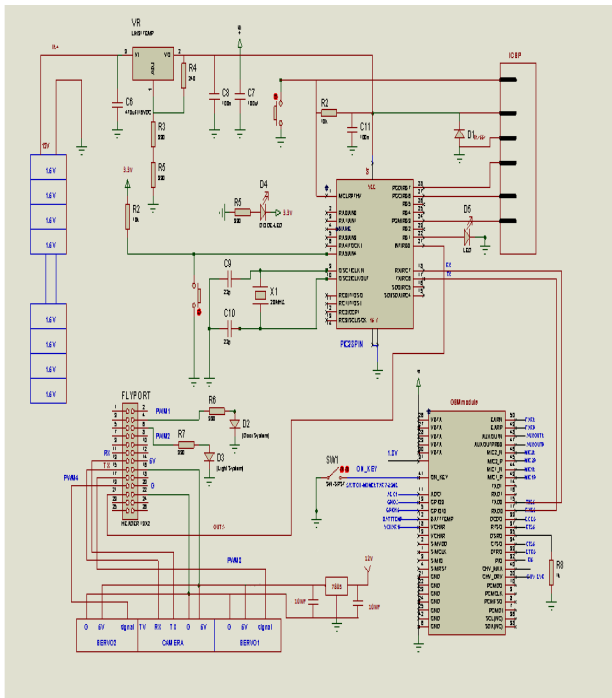

Figure 9. Circuit diagram of the receiver side.

B. Hardware Components

As shown in Fig. 10, the structure of our system consists mainly of commercial off-the-shelf components. Part (a) shows the EMOTIV EPOC headset that is used to record raw EEG signals and transmits that data to the computer via a Bluetooth module. The headset has 14 saline sensors to tune into subject’s brain electric signals, and two axis gyroscope for head movements. It has the capability to detect a wide range of thoughts and emotions such as excitement, engagement, meditation, and frustration. Further, left, right, up, down, push, pull movements, and facial actions like individual’s smiling, laughing, clenching, and smirking can be detected. All the data coming out from the headset is encrypted and passed to the computer. Emotiv software like (edk.dll) is used to decrypt this data and makes it available to the researchers who have an educational license.

Part (b) shows a Flyport module as well as a USB_UART (Universal Asynchronous Receiver-Transmitter) converter. This converter receives the commands from the PC through a USB connection, converts them into a UART, and sends them to the module. USB_UART converter is based on the FT232RL chip, while the Flyport is an 802.11 b/g/n WiFi compact module integrated with a microchip PIC 24FJ256GA106 processor. The Flyport has a 26 pin connector, powered with a 3.3 or 5V, and embeds with a TCP/IP stack for controlling the transceiver. It has several analog channels connected to the 10bit ADC, thus it can read input from sensors, and control other devices like servo motors and more. It can provide several services such as: Web server, TCP Socket, UDP Socket, SMTP Client, and Sntp Client.

All applications running on Flyport module are written using an openPicus IDE. TCP/IP stack embedded on this

module is based mainly on that one from Microchip. Consequently, openPicus IDE integrates the stack with the operating system (FreeRTOS) so as to ease the management of any TCP/IP operation. On that basis, we created an application using C# to exchange data between Emotiv Software and USB. Then, another two applications were created to exchange data between server and client. As shown in Fig. 11, once the data is available at the USB port, the server opens a TCP socket and initializes the UART. Going through the flow chart, we can see that the server sends the data to the client, and keeps lessening to the USB port. Following this mechanism, Fig. 12 shows how the client reads the socket and writes its contents to the UART. With this technique, the subject is able to convey his thought to any external hardware available at his surroundings.

Part (c) shows our system that interfaced to the home appliances. The system consists of the following: Flyport module, PIC-P40 board, ADH8066 module, and LinkSprite JPEG Colour camera. Following is a brief description for all modules.

PIC-P40 board has a 40 pins PIC microcontrollers socket, RS232 connector and MAX232 driver. Another socket was added to the board to hold the second microcontroller. The microcontroller that has been used for this project is PIC16F877. Both microcontrollers are powered by LM317 voltage regulator, and the oscillator circuit was made with 20 Mhz crystal oscillator. Since the RS232 is not compatible with the PIC microcontrollers, the MAX232 was connected to the first microcontroller using PIC UART Tx (pin number 25) and PIC UART Rx (pin number 26) to convert TTL level to RS232 level and vice versa. Likewise pins of port A for both microcontrollers were connected to 2 LEDs to simulate some appliances at home.

ADH8066 is a quad band GSM/GPRS communication module. This module has a SIM holder, RF connector to be connected with an external antenna, and UART interface to simplify the connection with the PIC microcontroller. Moreover, it supports standard AT commands which provides data communication functions. In this project, software was written and loaded to the microcontroller to send AT commands to the module. The software receives the user thought and commands the ADH8066 module to send SMS messages to a predefined number.

LinkSprite JPEG Colour camera is used to capture the image and send it to the subject. To capture the image from the camera, a specific command should be sent using the UART interface. Those commands were programmed and downloaded to the second microcontroller. Since the camera communicates at TTL Level; TXD, RXD, and GND pins of the camera were connected to the PIC UART pins. Two servo motors were used to move the camera left, right, up, and down respectively. A desktop application was written in C# to receive and present the image in front of the subject. As soon as the camera captured the image, user thought would be converted to a command to open the main gate of the house.

TABLE II

ADH8066 FEATURES

Feature	Description
Frequency	850/900/1800/1900 MHz
RF Output Power	2W
Sensitivity	<-106 dBm
Command	AT Command
Power voltage	3.4v-4.5v
Average Current	<2.5mA
SIM	Standard SIM
Protocol	Support GSM/GPRS
RF connector	50 ohm
SMS	Support PDU
Maximum baud rate	115,200 bps



(a)



(b)



(c)

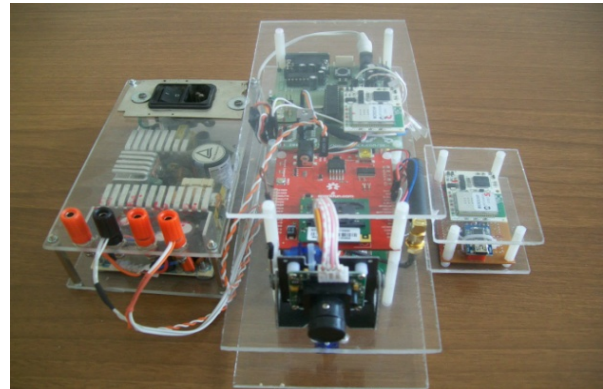

(d)

Figure 10. Demonstration of the practical BCI system, (a) EMOTIV EPOC neuroheadset, (b) FLYPORT WiFi module, (c) PIC-P40, ADH8066, and LinkSprite camera, (d) The whole system with the power unit.

IV. EXPERIMENTAL RESULTS

The experiment consists of several runs and each lasts 12 seconds. The data is collected from a healthy male subject. We used the research edition SDK that includes an EMOTIV EPOC EEG neuroheadset as shown in Fig. 10 Part (a), EMOTIV EPOC Control Panel as shown in Fig. 6, EmoComposer as shown in Fig. 13, EmoKey and TestBench are shown in Fig. 8 and Fig. 14 respectively. The subject's task was to use cognitive suite to control left, right, pull, and push movements of a virtual cube designed by EMOTIV. The subject was seated in front of the PC running EMOTIV software and was instructed to perform the appropriate imagery task to move the virtual cube to the desired direction. We simulated the environment with two LEDs to evaluate the opening of the door and switching the lights in the real world. Command for controlling the messages were directed to a real time hardware interface circuit. Control signals for the modem (ADH8066 module) and LEDs were dependent on the movement of the virtual cube supplied by cognitive suite. The Emokey software was used for mapping the cognitive actions to keyboard input. The actions push, pull, left, and right were mapped to the keys (i), (l), (k), and (m) respectively.

The system was connected to the BCI through a client-server protocol. The system acts as a client while computer running the BCI software acts as a server. After every stimulus, the BCI system processes the brain signals and converts them into a keystroke. We created an application using C# to exchange data between BCI and the system via a TCP-IP socket. The code is divided into two basic parts: listening for a key pressed, and sending the corresponding commands to the server through the USB port. Once the keystroke is done, the server sends a data string of one byte, and the client responds accordingly. The time interval between the BCI command and the activity was set at 4.0s. The system triggered one output each time it received a command from the BCI. To trigger the activity to the original case, the system should receive the same command in the second run, this means that each activity could run in minimum of 10 seconds. Opening of the door depends on

the camera attached to the BCI system. The image of the camera was transmitted in streaming over a WiFi to the computer that is placed in front of the user. Any changes in the image were given a priority in issuing a command to open the door. The data for the left, right, pull, and push movements of a virtual cube was collected and shown in Fig.14. Further analysis were conducted using EEGLAB and shown in Fig.15.

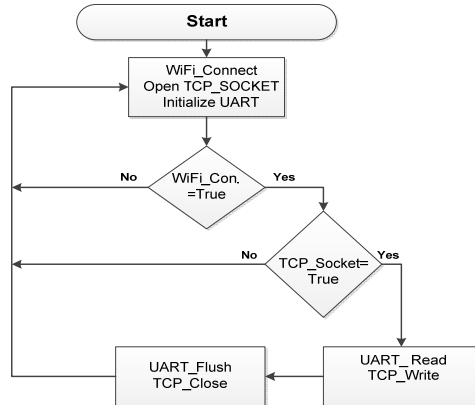

Figure 11. Server action while sending subject's thought.

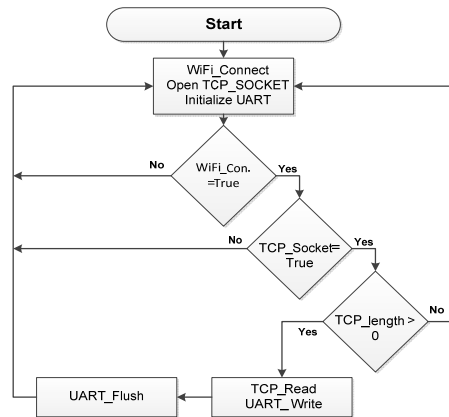

Figure 12. Client action while receiving subject's thought.

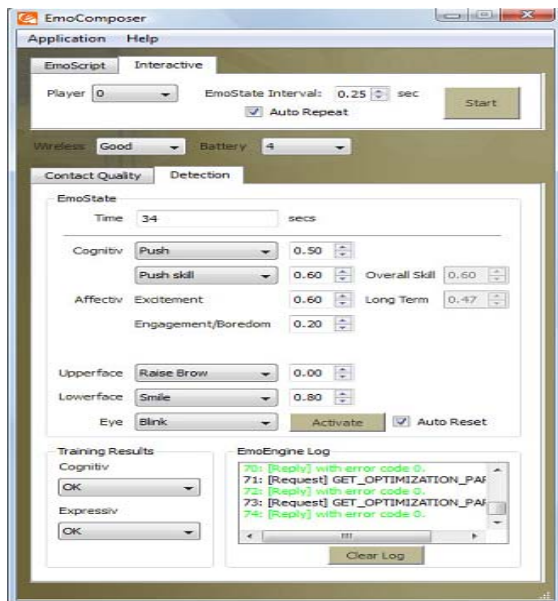
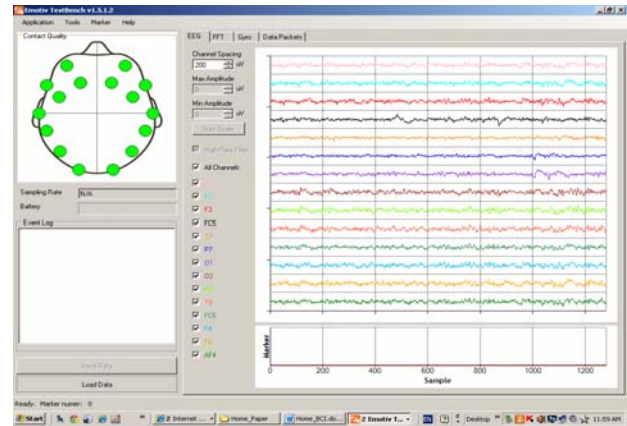
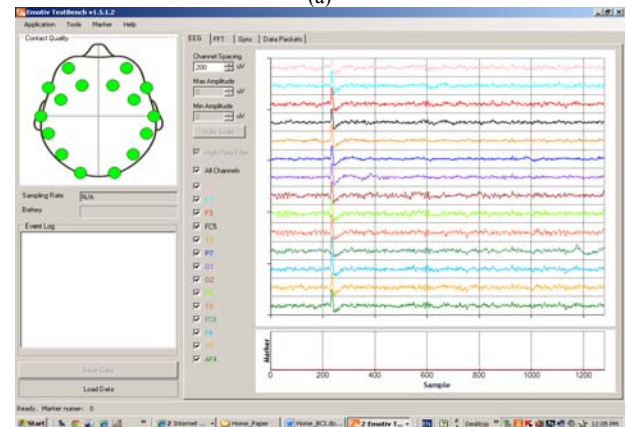

Figure 13. EmoComposer suite.



(a)



(b)

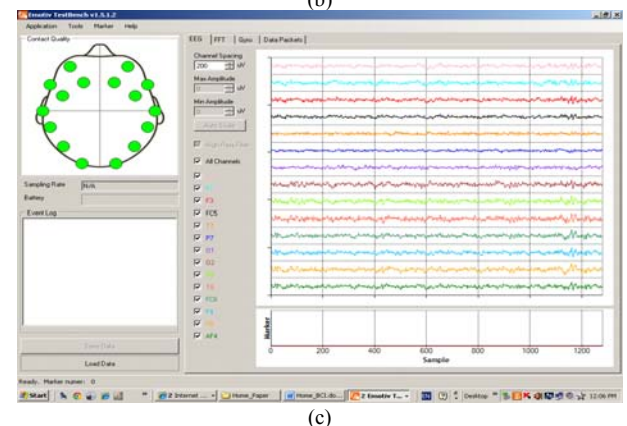

(c)

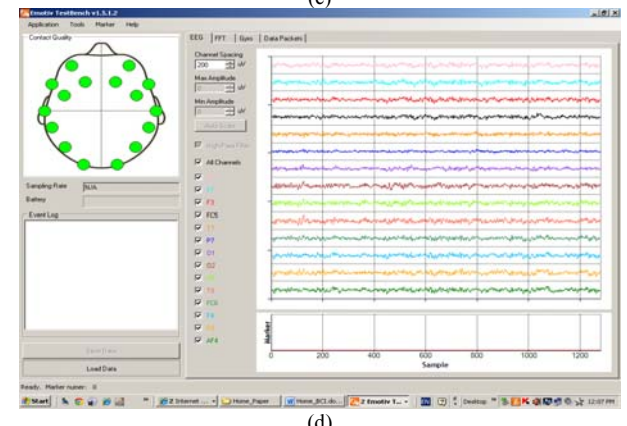

(d)

Figure 14. Real-time EEG Measurements in TestBench: (a) Left, (b) Right, (c) Pull, (d) Push. The data shown corresponds to the 14 channels being picked up by the EMOTIV EPOC EEG Neuroheadset.

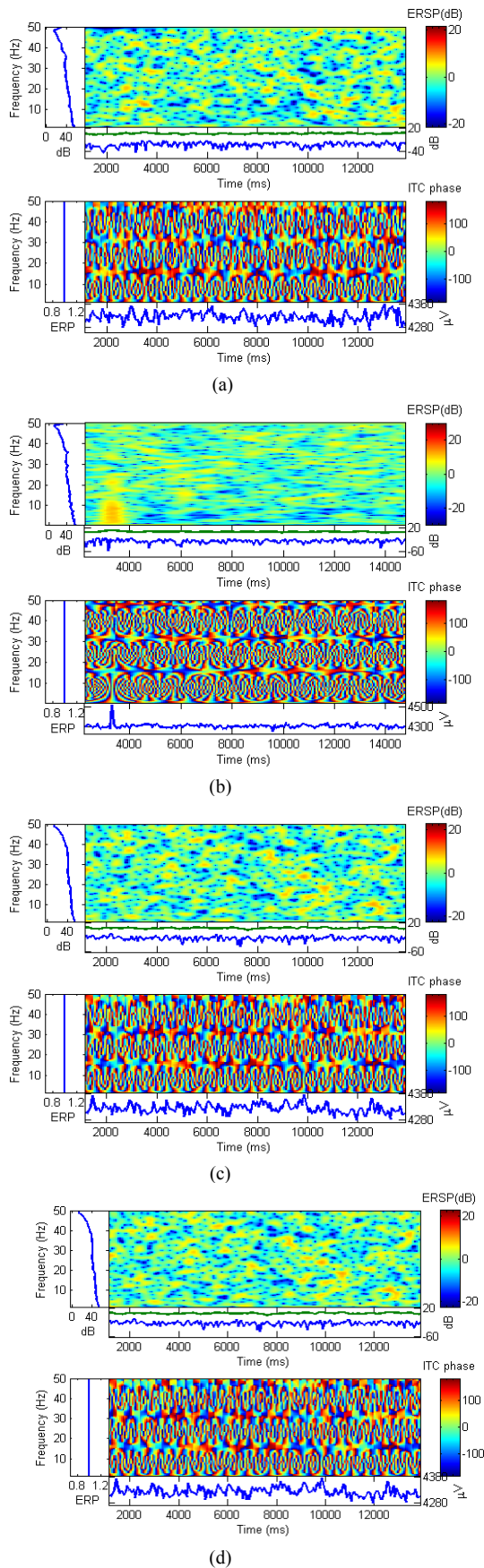

Figure 15. Real-time EEG Measurements in TestBench: (a) Left, (b) Right, (c) Pull, (d) Push. The data shown are processed using EEGLAB

V. CONCLUSION AND FUTURE WORK

In this study, a real-time EEG-based brain-computer system was proposed for controlling home appliances. The system consists mainly of an EMOTIV EPOIC headset and an embedded module. The embedded module is based on the PIC16F877 chip and some peripherals. The prototype allows home appliances to be controlled successfully through the subject's brain electrical activity in real-time performance. EMOTIV EPOC headset was used to record EEG signal and transmits that data to the computer via a Bluetooth module. The received EEG data was processed by the software provided by EMOTIV and results were transmitted to the embedded system to control the appliances through a WiFi module. A Graphical User Interface (GUI) was developed to detect a key stroke and converted it to a certain command. One male subject participated in the experiment. We trained the subject to the cognitive suite to control left, right, pull, and push movements of a virtual cube. The experimental results demonstrate the feasibility of our proposed BCI system in controlling home appliances based on the user's physiological states. Moreover, the modular approach applied in designing this system will give us the opportunity to configure it for different application scenarios in future.

REFERENCES

- [1] S. G. Mason, M. M. Moore Jackson, and G. E. Birch, "A general framework for characterizing studies of brain interface technology," in *Annals of Biomedical Engineering*, vol. 33, no II, pp 1653-1670, Nov. 2005.
- [2] C. Guger, A. Schlögl, C. Neuper, D. Walterspacher, T. Strein, and G. Pfurtscheller, "Rapid prototyping of an EEG-based brain-computer interface (BCI)," *IEEE Transactions on Neural Systems and Rehabilitation Engineering*, vol. 9, no. 1, pp. 49-58, March 2001.
- [3] T. M. Vaughan, J. R. Wolpaw, and E. Donchin, "EEG-based communication: Prospects and problems," *IEEE Transactions on Neural Systems and Rehabilitation Engineering*, vol. 4, no. 4, pp. 425-430, Dec 1996.
- [4] K. R. Müller and B. Blankertz, "Toward non-invasive brain-computer interfaces," *IEEE Signal Processing Magazine*, vol. 128, no. 1, pp. 125-128, 2006.
- [5] J. R. Wolpaw, N. Birbaumer, D. J. McFarland, G. Pfurtscheller, and T. M. Vaughan, "Brain-computer Interface for Communication and Control," *Clinical Neurophysiology*, vol. 133, pp. 767-791, 2002.
- [6] Benbadis, Selim, *et al.* "Handbook of EEG Interpretation." Demos Medical, 2007.
- [7] S. Helal, W. Mann, H. E. Zabadani, J. King, Y. Kaddoura, and E. Jansen, "The gator tech smart house: A programmable pervasive space," *IEEE Comput. Soc.*, vol. 38, pp. 50-60, 2005.
- [8] C. Yerrapragada and P. S. Fisher, "Voice controlled smart house," *IEEE Int. Conf. on Consumer Electronics*, vol. 1, pp. 154-155, 1993.
- [9] M. Cheng, X. R. Gao, S. K. Gao, and D. F. Xu, "Design and Implementation of a Brain-computer Interface with High Transfer Rates," *IEEE Trans. Biomed. Eng.*, vol. 49, pp. 1181-1186, 2002.
- [10] N. Birbaumer, N. Ghanayim, T. Hinterberger, I. Iversen, B. Kotchoubey, A. Kübler, J. Perelmouter, E. Taub, and H.

- Flor, "A spelling device for the paralysed," *Nature*, vol. 398, pp. 297-298, 1999.
- [11] J. R. Wolpaw, N. Birbaumer, G. Pfurtscheller, D. J. McFarland, and Brain, "Computer interfaces for communication and control," *Journal of Clinical Neurophysiology*, vol. 113, pp 529-538, 2002.
- [12] A. Furdea, S. Halder, D. J. Krusienski, D. Bross, F. Nijboer, N. Birbaumer, and A. Kubler, "An auditory oddball (P300) spelling system for brain-computer interfaces," *Psychophysiology*, vol. 46, no. 3, pp. 617-625, 2009.
- [13] V. Bostanov, "BCI Competition 2003{Data sets IB and IIB: Feature extraction from event-related brain potentials with the continuous wavelet transform and the T-value scalogram," *IEEE Transactions on Biomedical Engineering*, vol. 51, no. 6, pp. 1057-1061, 2004.
- [14] A. B. Schwartz, D. M. Taylor, and S. I. Tillery, "Extraction algorithms for cortical control of arm prosthetics," *Curr. Opin. Neurobiol*, 11 701-7, 2001.
- [15] J. R. Mill and J. Mourino, "Asynchronous BCI and local neural classifiers: An overview of the adaptive brain interface project," *IEEE Transactions on Neural Systems and Rehabilitation Engineering*, Special Issue on Brain-Computer Interface Technology, 2003.
- [16] G. Pfurtscheller, C. Neuper, D. Flotzinger, and M. Pregenzer, "EEG-based Discrimination between Imagination of Right and Left Hand Movement," *Electroencephalography and Clinical Neurophysiology*, vol. 103, pp. 642-651, 1997.
- [17] G. Pfurtscheller, C. Neuper, A. Schlogl, and K. Lugger, "Reparability of EEG signals recorded during right and left motor imagery using adaptive autoregressive parameters," *IEEE Transactions on Rehabilitation Engineering*, vol. 6, no. 3, 1998.
- [18] S. Bhattacharyya, A. Khasnobish, S. Chatterjee, A. Konar, and D.N. Tibarewala, "Performance analysis of LDA, QDA and KNN algorithms in left-right limb movement classification from EEG data," in *Systems in Medicine and Biology (ICSMB)*, 2010, pp. 126 - 131.
- [19] Y. Li, C. Guan, H. Li, and Z. Chin, "A self-training Semi-supervised SVM Algorithm and its application in an EEG-based Brain Computer Interface Speller System," *Pattern Recognition Letters*, vol. 29, no. 9, pp. 1285-1294, 2008.
- [20] L. R. Rabiner, "A tutorial on hidden markov models and selected applications in speech recognition," in *Proc. of the IEEE*, 1989, pp. 257-286.

Abdel Ilah Alshbatat is an academic staff member at Tafila Technical University in the Electrical Engineering Department, Faculty of Engineering, Tafila, Jordan.

Peter James Vial is an academic staff member at the University of Wollongong in the School of Electrical, Computer and Telecommunications Engineering, in the Faculty of Engineering and Information Sciences, Wollongong.

Prashan Premaratne is an academic staff member at the University of Wollongong in the School of Electrical, Computer and Telecommunications Engineering, in the Faculty of Engineering and Information Sciences, Wollongong.

Le Chung Tran is an academic staff member at the University of Wollongong in the School of Electrical, Computer and Telecommunications Engineering, in the Faculty of Engineering and Information Sciences, Wollongong.